







36 607 985

- rosette 60 x 60 mm
- head part with cut-to-length spindle and sleeve



	Brushed Dark Platinum	36 607 985-99
	Chrome	36 607 985-00
	Brushed Platinum	36 607 985-06
	Platinum	36 607 985-08
	Brushed Durabronze (23kt Gold)	36 607 985-28
	Brushed Chrome	36 607 985-93

Required miscellaneous



- Wall valve 1/2" -** 35 607 970 90
- max. recess depth 145 mm
 - min. recess depth 75 mm

36 607 985

mm [inches]

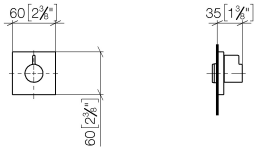

Certificates

DVGW_DW-
6501DN0116.

WRAS_2011026.

IAPMO_4976 (2).

LGA_29931.

WRAS_2010066.

DVGW_DW-
6512DN0706.

LGA_29932.

36 607 985

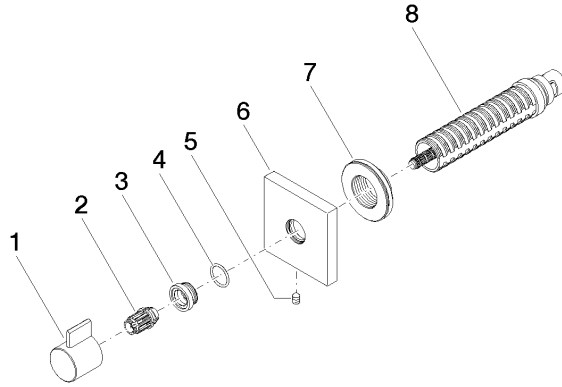

Spare parts list

No.	Item Number	Name	Quantity used	Delivery time
1	09 20 98 002-99	handle	1	30
2	09 12 12 005 90	fixing cap	1	2
3	09 12 12 043-99	base	1	30
4	09 14 10 017 90	seal	1	2
5	90 31 11 004 00 90	pin	1	2
6	09 27 98 014-99	rosette	1	30
7	09 21 02 151 90	sleeve	1	2
8	90 90 03 202 00 90	top	1	2